

Economy Series

ES4 ES6 EC3 EC4

EC4

Model Configuration

Model	Ball screw lead	Stroke	Sensor	Motor*	Holding brake
EC4	006	0150	0	23S21	0
	006: 6 mm	0050: 50 mm	0: Without	23S21	0: Without
	012: 12 mm	to		23E21	1: Holding brake
		0300: 300mm			

* encoder res. 40.000 inc/rev

Dimensions

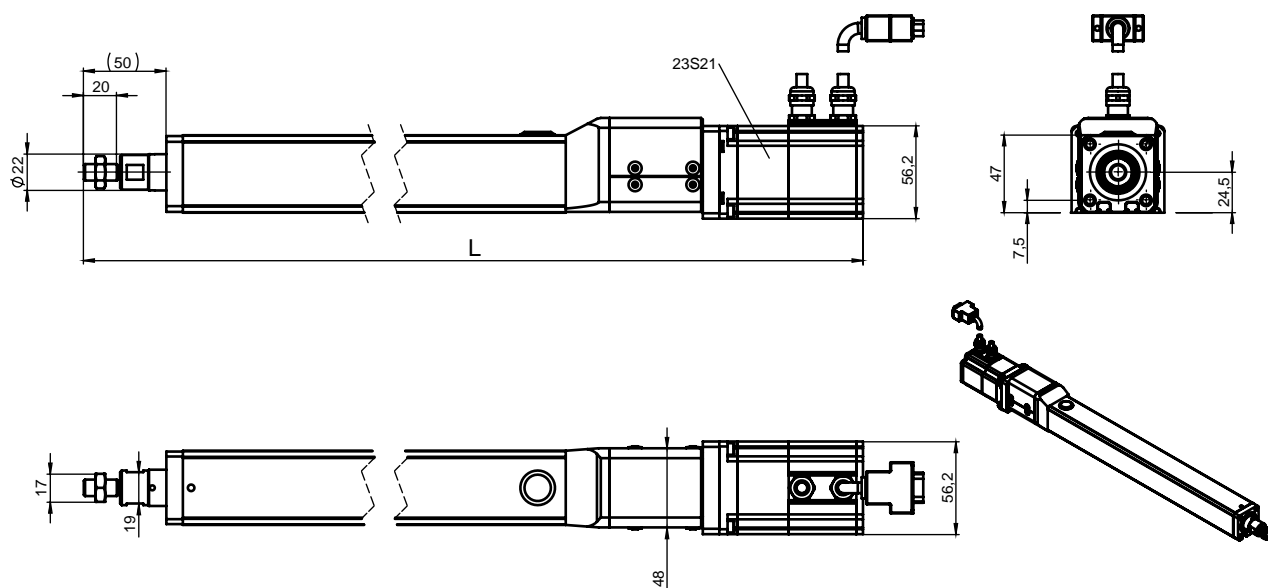

Additional mounting equipment available.

		EC4-xxx-0050	EC4-xxx-0300
Length* L	[mm]	333.5	583.5

* depends on motor type and holding brake

Basic Specifications (Axis)

Series EC4-xxx			
Ball screw portion	Shaft diameter [mm]	Ø6	Ø12
	Lead [mm]	6	12
	Basic dynamic load rating Ca [N]	1770	920
	Basic dynamic load rating COa [N]	3040	1600
	Root diameter [mm]	Ø6.8	
	Ball center-to-center diameter [mm]	Ø8.4	
Bearing portion	Axial direction - Basic dynamic load rating Ca [N]	8000	
	Axial direction - Static permissible load PO [N]	3240	
Permissible rotational speed [min ⁻¹]		3000	
Starting torque [Nm]		0.022	0.042
Positioning repeatability [mm]		±0.020	
Lost motion [mm]		0.1	
Maximum input torque [Nm]		0.35	

Basic Specifications (Axis and Motor)

		Series EC4-006		Series EC4-012	
Rated Values					
Mounting position		vertical	horizontal	vertical	horizontal
Ball screw	[mm]	8x6		8x12	
Acceleration	[m/s ²]	2	3	2	3
Velocity	[m/s]	0.2	0.2	0.35	0.35
Load	[kg]	12	40	4.5	25
Feed force	[N]	24	120	9	75
Resolution / Accuracy					
Positioning resolution ¹⁾	[µm]	0.15		0.3	
Repeatability	[µm]	±20			
Accuracy	[µm]	100			

1) Encoder resolution 40.000 inc/rev

Amplifier Specifications

		ECOVARIO 114	ECOVARIO 114D	ECOMiniDual
1-phase AC Supply				
Supply voltage	V _{AC}	20 .. 48	-	-
Line frequency	Hz	50 .. 60	-	-
Rated power	VA	480	-	-
DC Supply				
Supply voltage	V _{DC}	24 .. 70	24 .. 70	24 .. 70
Rated power	W	700	960	260



ECOVARIO 114





ECOMiniDual

Actuator Units

NEW All-in-one-solution

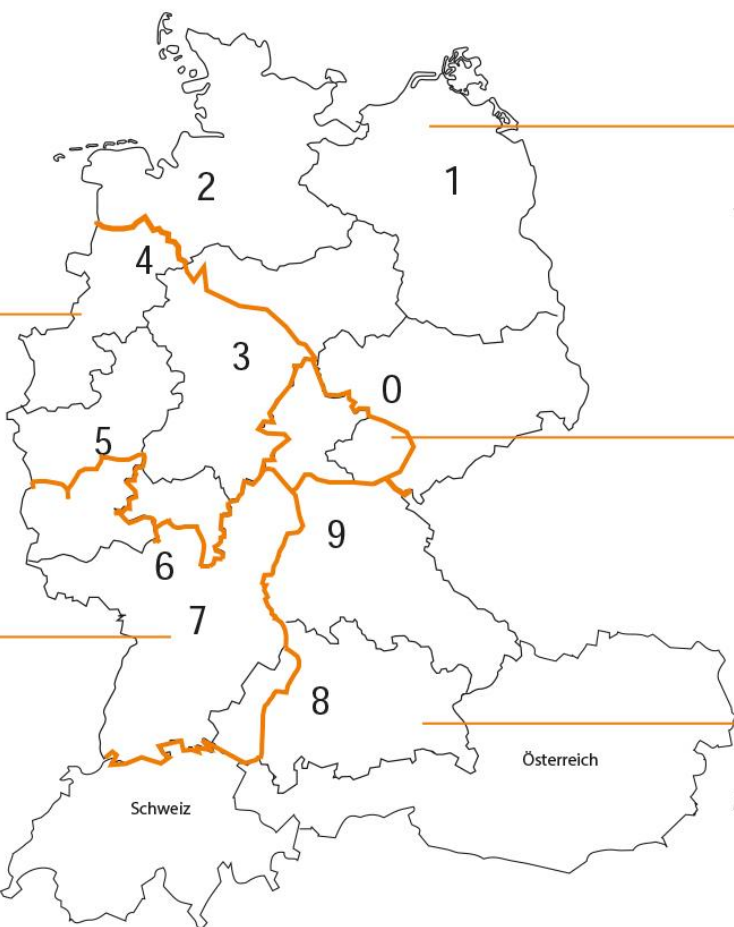
Contact Persons:







Christopher Kohaut
PLZ:
32-37
4
50-53, 57-59
60-63, 65



Kurt Hokenmaier
PLZ:
54-56
64, 66-69
7
88-89
97



Thomas Haugk
PLZ:
01-06, 08-09
1
2
30, 31, 38, 39



Hanno Starker
PLZ:
07
98-99



Marco Schwarz
PLZ:
8-87
90-96
Österreich
Schweiz

Thomas Haugk	Tel.: +49 3641 63376-903	thomas.haugk@jat-gmbh.de
Christopher Kohaut	Tel.: +49 3641 63376-913	christopher.kohaut@jat-gmbh.de
Hanno Starker	Tel.: +49 3641 63376-43	hanno.starker@jat-gmbh.de
Kurt Hokenmaier	Tel.: +49 151 61088773	kurt.hokenmaier@jat-gmbh.de
Marco Schwarz	Tel.: +49 3641 63376-907	marco.schwarz@jat-gmbh.de